

KONSTRUKCJE Temat 1 – rozwiązane zadania

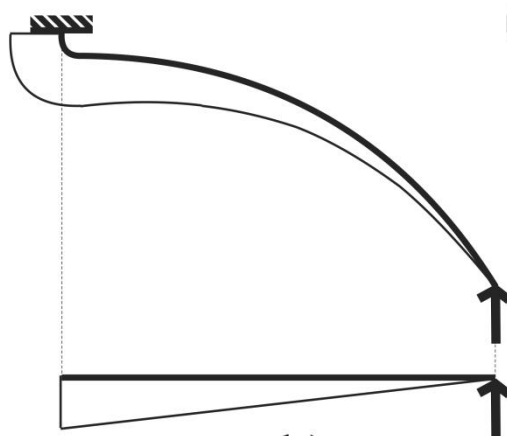

a)



b)

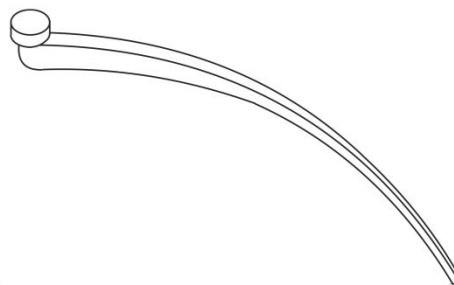

c)



d)

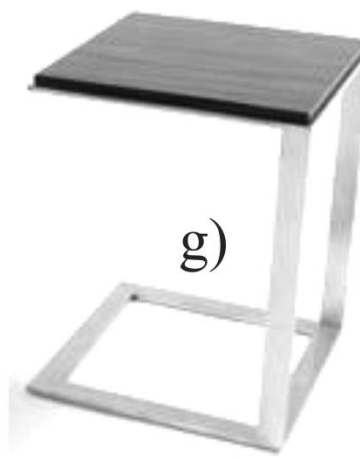
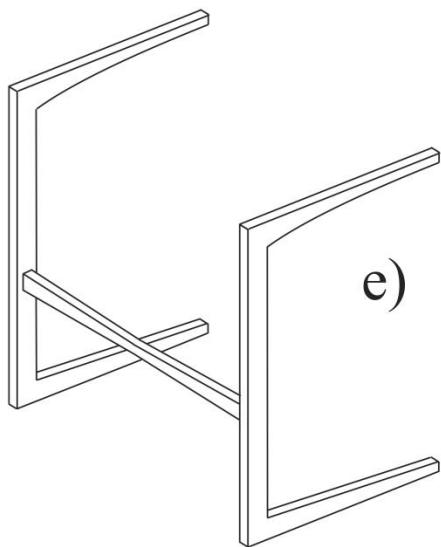
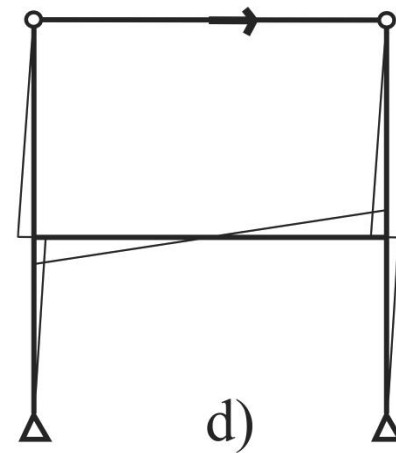
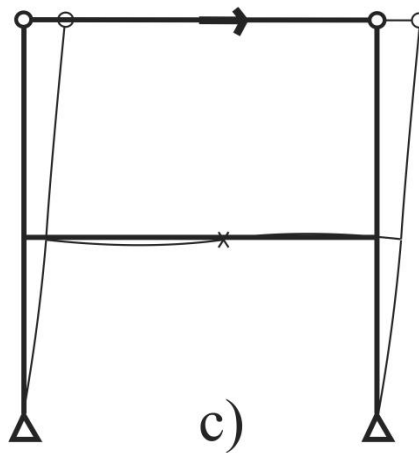
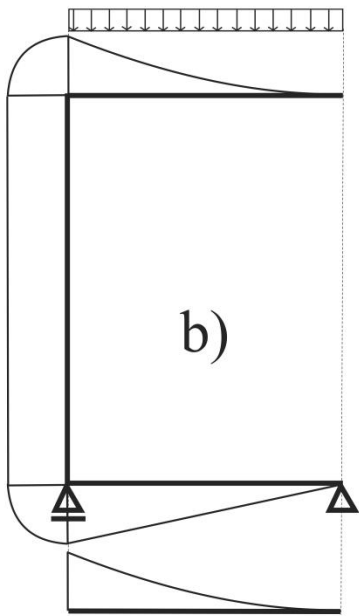
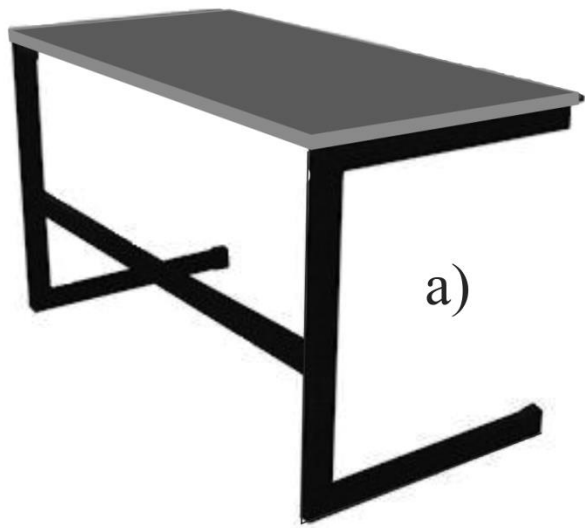

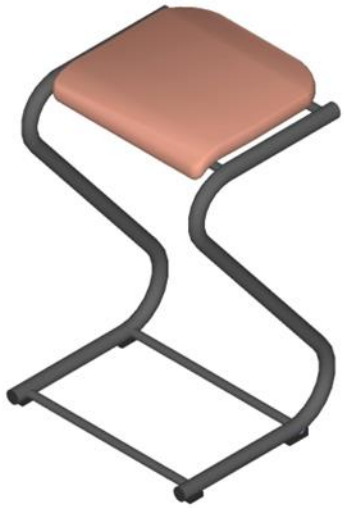

a

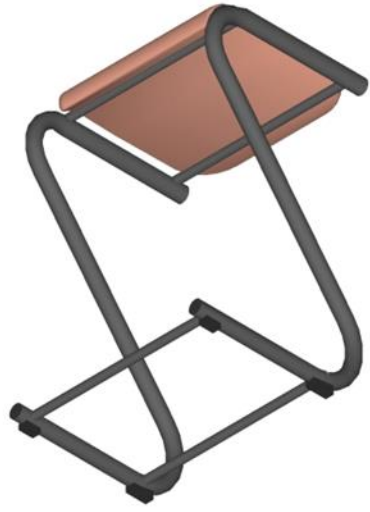

b



c

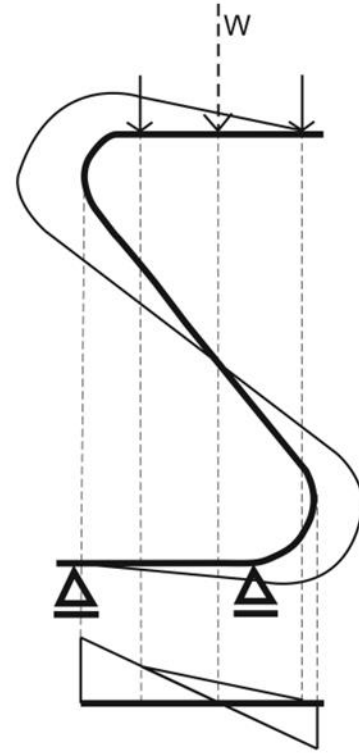

d

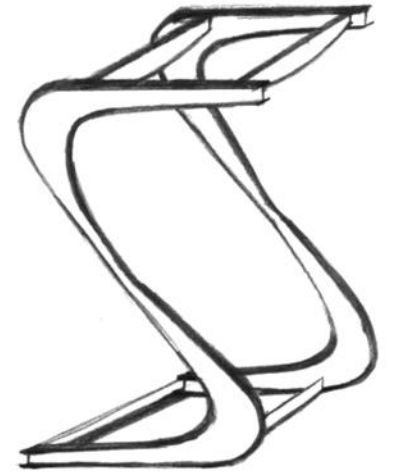

e

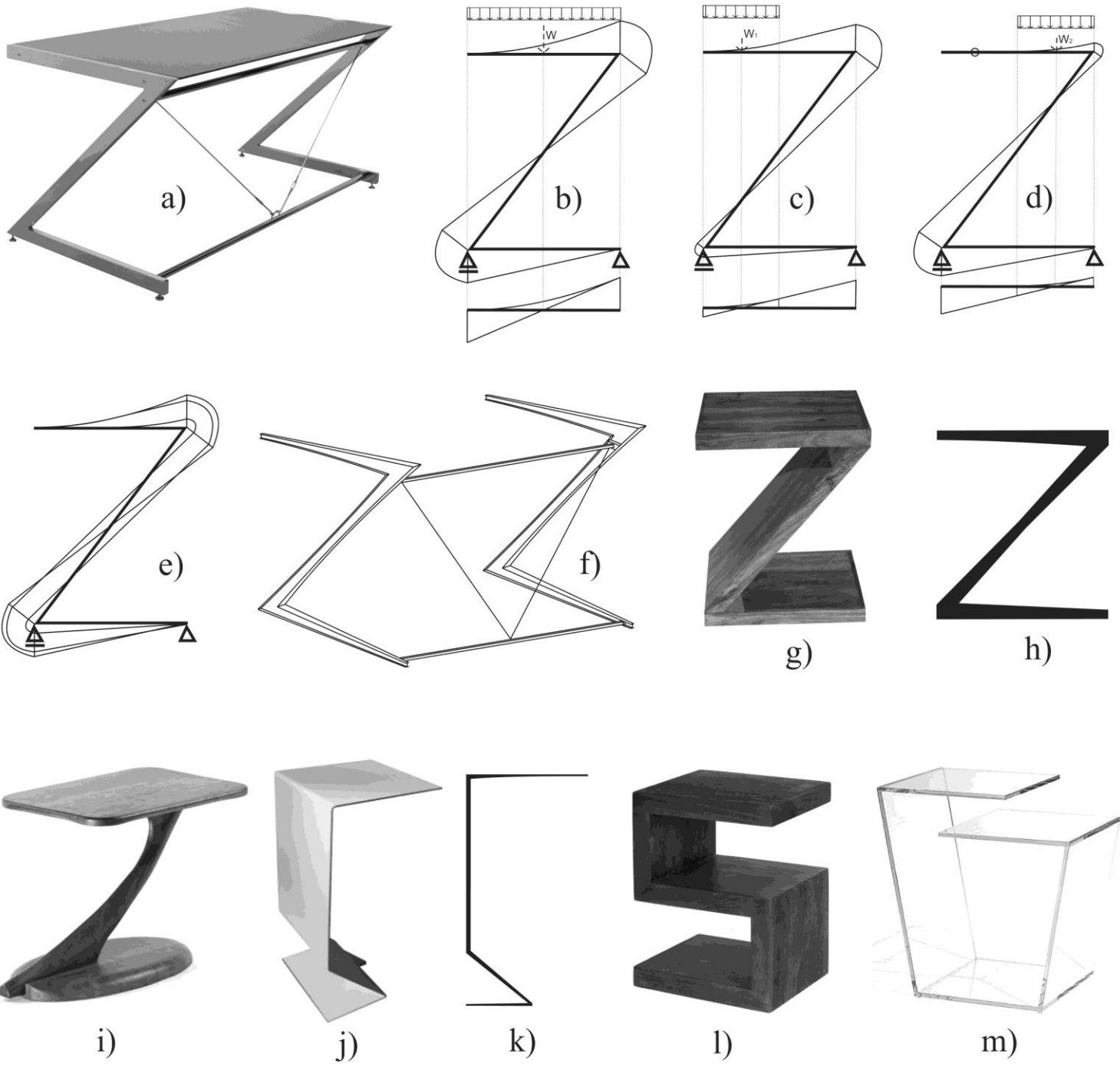

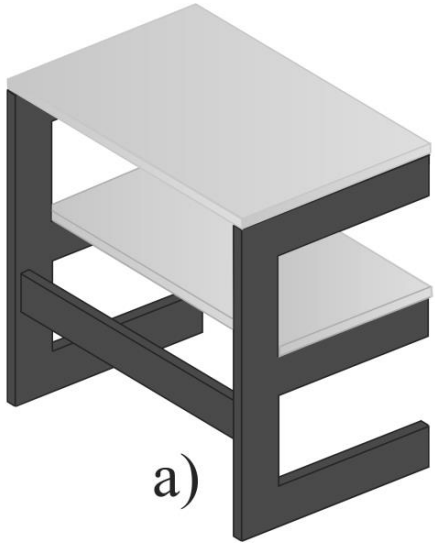

a)

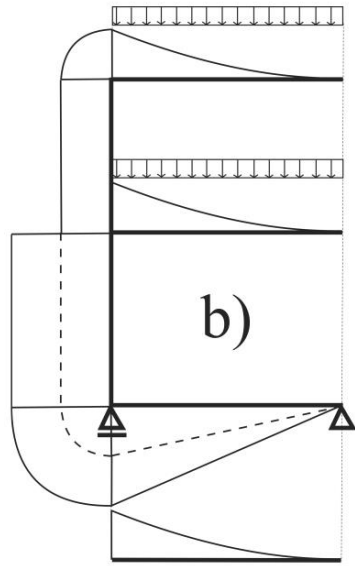

b)

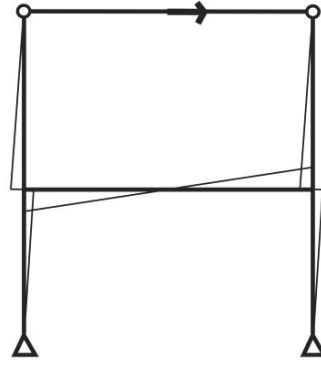

c)

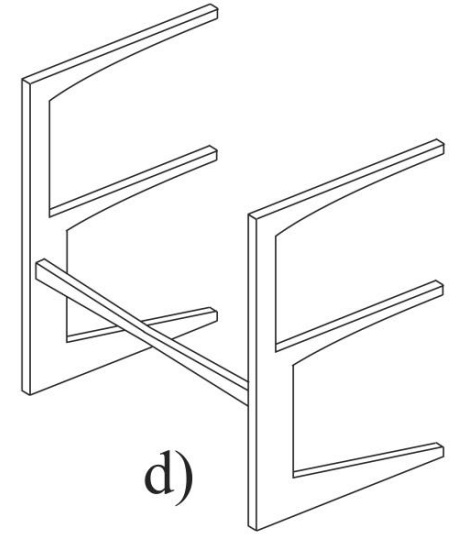

d)



e)



f)



g)



h)